

# Vulcan Audio Rack

STEP 1

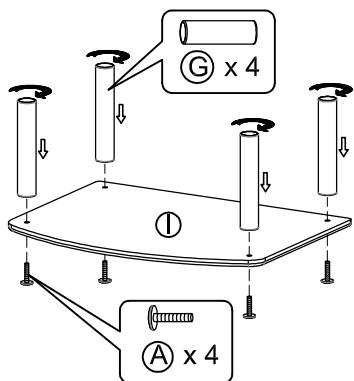

STEP 2

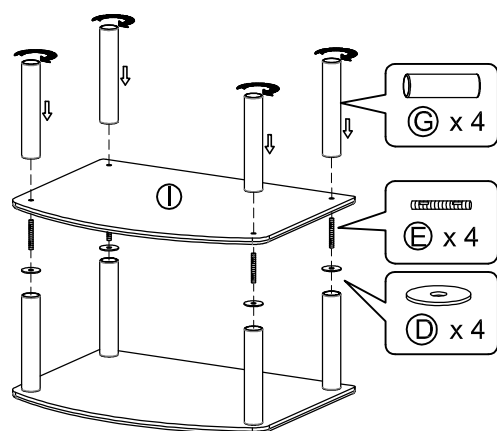

STEP 3

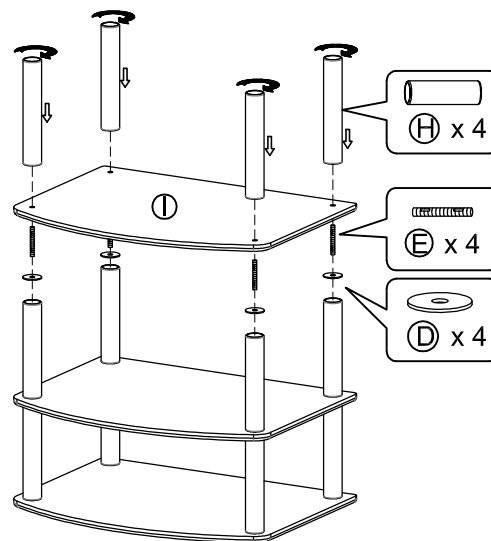

STEP 4

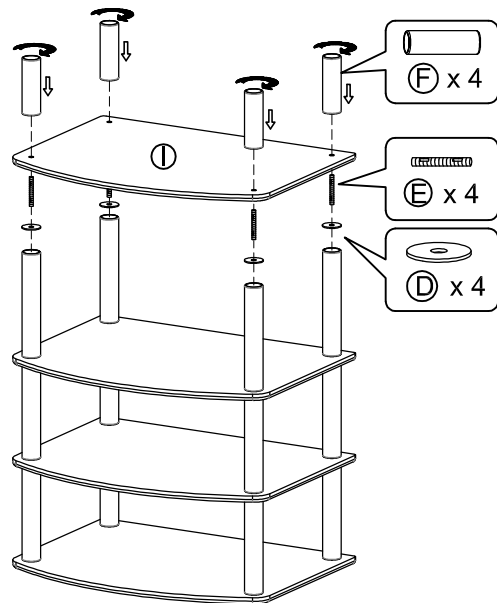

STEP 5

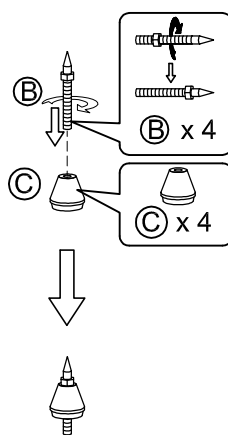



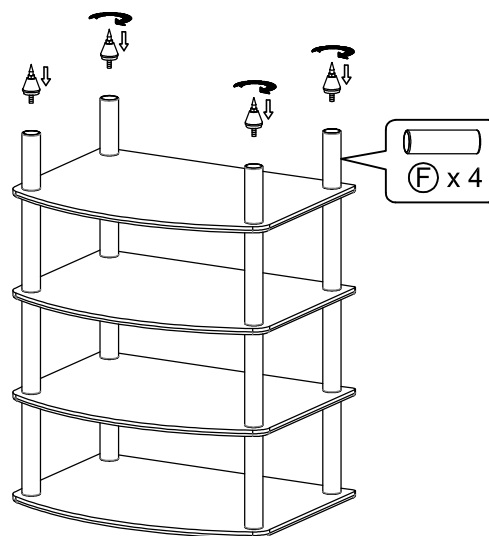

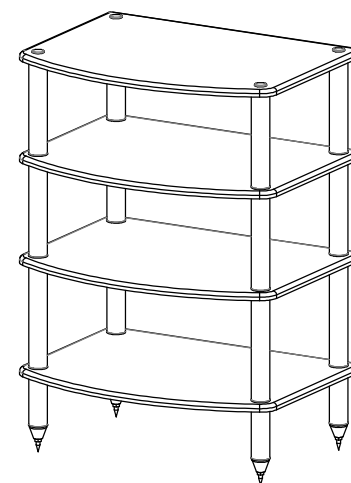

STEP 6

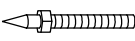

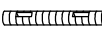
STEP 7

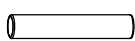
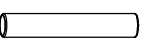

NO.	DESCRIPTION	QTY
A	M8*40 	4
B	M8*82 	4
C	∅ 38*30 	4
D	∅ 39*2 	12
E	M8*62 	12
F	L=96 	4
G	L=184 	8
H	L=223 	4
I	T=15mm 	4